



# Eclipse® Enhanced Model 705 GWR Level Transmitter for Sanitary Applications

## DESCRIPTION

The Enhanced Eclipse Model 705 is a loop-powered, 24 VDC, level transmitter based upon the revolutionary Guided Wave Radar (GWR) technology. This transmitter offers enhanced reliability, as demonstrated by a Safe Failure Fraction of 91%. (Suitable for SIL2 applications)

This Eclipse transmitter is designed to provide measurement performance well beyond that of many traditional technologies.

Eclipse supports the FDT/DTM standard and a PACTware™ PC software package allows for additional configuration and trending flexibility.

## TECHNOLOGY

Eclipse Guided Wave Radar is based upon the technology of TDR (Time Domain Reflectometry). TDR utilizes pulses of electromagnetic energy transmitted down a probe. When a pulse reaches a surface that has a higher dielectric than the air/vapor in which it is traveling, the pulse is reflected. An ultra high-speed timing circuit precisely measures the transit time and provides an accurate level measurement.

Eclipse GWR can be utilized to detect overall level or interface level, and when used with a HART® splitter, it can transmit two 4–20 mA signals.

## APPLICATIONS

**MEDIA:** Liquids or slurries; hydrocarbons to water-based media (dielectric 1.9–100).

**VESSELS:** Most process or storage vessels, up to rated probe temperature and pressure.

**CONDITIONS:** Virtually all level measurement and control applications including process conditions exhibiting visible vapors, foam, coating/buildup, surface agitation, bubbling or boiling, high fill/empty rates, low level and varying dielectric media or specific gravity.



## FEATURES

- Two-wire, 24 VDC, loop-powered transmitter for level, interface, or volume
- HART or optional FOUNDATION fieldbus™ digital communications
- Performance not process dependent (changing specific gravity and dielectric constant have no significant effect)
- No level change needed for configuration; no field calibration necessary
- 20-point custom strapping table for volumetric or flow measurement
- Low dielectric measurement capability  $\epsilon_r \geq 1.9$  (including Hexane)
- Can measure reliably to very top of vessel
- Probes available in 316 SS, AL6XN and Hastelloy® C22 (Certification included with standard documentation package)
- IS, XP, and Non-Incendive approvals
- Two-line, 8-character LCD and 3-button keypad (opt.)
- Quick connect/disconnect probe coupling
- Third Party Safety Integrity Level (SIL) data (FMEDA analysis) for Safety Instrument Systems engineering is available. HART® version is suitable for SIL 2 loops (Safe Failure Fraction, SFF = 91%)
- 15Ra electropolished probe rod finish/32Ra housing finish

# TRANSMITTER SPECIFICATIONS

## FUNCTIONAL / PHYSICAL

Signal output		4–20 mA with HART 3.8 to 20.5 mA usable (meets NAMUR NE 43) FOUNDATION fieldbus™ H1(ITK4.6) (optional)
Span		6 inches to 20 feet (15 to 610 cm)
Resolution	Analog Display	0.01 mA 1 mm
Loop resistance		630 Ω @ 24 VDC (20.5 mA)
Damping		Adjustable 0–10 seconds
Diagnostic alarm		Adjustable 3.6 mA, 22 mA, or HOLD
User interface		3-button keypad, HART communicator, or FOUNDATION fieldbus™
Display		2-line × 8-character LCD
Power (at terminals)		
General purpose/Intrinsically safe		11 to 36 VDC
Explosion proof (with intrinsically safe probe)		11 to 36 VDC
FOUNDATION fieldbus: General Purpose/XP		9 to 32 VDC
Foundation fieldbus: IS/Fisco		9 to 30 VDC
Menu language		English, Spanish, French and German
Housing material		Aluminum A356T6 (< 0.2% copper) 304 stainless steel deep drawn (optional)
Net/Gross weight	Aluminum 304 stainless steel	6 lbs (2.36 kg) / 7 lbs (2.76 kg) 3 lbs (1.36 kg) / 4 lbs (1.49 kg)
Overall dimensions	Aluminum 304 stainless steel	H 8.43" (214 mm) x W 4.38" (111 mm) x D 7.40" (188 mm) H 4.5" (114mm) x W 3.0" (76mm)



## PERFORMANCE

Reference conditions	Reflection from water at +70° F (+20° C) with 72" single rod probe in metal vessel (CFD threshold)
Linearity ①	< 0.1% of probe length or 0.1 inch (3 mm) (whichever is greater)
Measured error ①	±0.1% probe length or ±0.1 inch (3 mm) maximum
Resolution ②	±0.1 inch (1 mm)
Repeatability ②	< 0.1 inch (±0.025% of Volume)
Hysteresis ②	< 0.1 inch (1 mm)
Response time	< 1 second
Warm-up time	< 5 seconds
Operating temperature range	-40° to +175° F (-40° to +80° C)
LCD readable temperature range	-5° to +160° F (-20° to +70° C)
Operating temperature effect	±0.02% of probe length / °C
Humidity	0-99%, non-condensing
Electromagnetic compatibility	Meets CE requirements (EN 61000-6-2/2001, EN 61000-6-4/2001) (Probes must be used in metallic vessel to maintain CE compliance)
SIL 2 (optional)	Safe Failure Fraction (SFF) 91%

① Specification for top 12 inches of single rod will be application dependent.

② When used with strapping table

# AGENCY APPROVALS

AGENCY	MODEL APPROVED	APPROVAL CATEGORY	APPROVAL CLASSES
	705-5XXX-1XX	Intrinsically Safe ③	Class I, Div. 1; Groups A, B, C, & D Class II, Div. 1; Groups E, F, & G T4 Class III, NEMA 4X, IP66 Entity
	705-5XXX-2XX		
	705-5XXX-3XX	Explosion Proof ① (with Intrinsically Safe probe)	Class I, Div. 1; Groups B, C & D Class II, Div. 1; Groups E, F, & G T4 Class III, NEMA 4X, IP66
	705-5XXX-4XX		
	705-5XXX-XXX	Non-Incendive Suitable for: ②	Class I, Div. 2; Groups A, B, C, & D Class II, Div. 2; Groups F & G T4 Class III, NEMA 4X, IP66
	705-5XXX-XXX		
	705-5XXX-1XX	Intrinsically Safe	Class I, Div. 1; Groups A, B, C, & D Class II, Div. 1; Group G T4 Class III, Type 4X Entity
	705-5XXX-2XX		
	705-5XXX-3XX	Explosion Proof ① (with Intrinsically Safe probe)	Class I, Div. 1; Groups B, C & D Class II, Div. 1; Group G T4 Class III, Type 4X
	705-5XXX-4XX		
	705-5XXX-XXX	Non-Incendive Suitable for: ②	Class I, Div. 2; Groups A, B, C, & D Class II, Div. 2; Group G T4 Class III, Type 4X
	705-5XXX-XXX		
	705-5XXX-AXX	Intrinsically Safe	Ⓢ II 1G D, EEx ia IIC T4
	705-5XXX-BXX		
	705-5XXX-CXX	Flame Proof ①	Ⓢ II 1/2G, EEx d [ia] IIC T6
	705-5XXX-DXX		
	705-5XXX-EXX	Non-sparking ②	Ⓢ II 3G, EEx n II T4..T6
705-5XXX-FXX			

① Factory Sealed: This product has been approved by Factory Mutual Research (FM), and Canadian Standards Association (CSA), as a Factory Sealed device.

② **IMPORTANT:** Measured media inside vessel must be non-flammable only. If media inside vessel is flammable, then the explosion proof version (which contains an internal barrier making the probe Intrinsically Safe) is required.

③ Sanitary enclosure is an “end of line” device. Enclosure contains a single conduit entry. Second conduit entry is plugged and sealed.



These units are in conformity of:

1. The EMC Directive: 89/336/EEC. The units have been tested to EN 61000-6-2/2001 and EN 61000-6-4/2001.
2. Directive 94/9/EC for equipment or protective system for use in potentially explosive atmospheres.

# PACTWARE PC SOFTWARE PROGRAM

---

PACTware PC software and the new Field Device Tool (FDT) standard take radar level measurement to a new level of setup efficiency and user-friendliness. The powerful Eclipse guided wave radar transmitter with its linear program has always been easy to use. PACTware builds on that ease of use by adding a graphical software interface. Simply connect your PC through a serial interface to the HART loop and all functionality can be accessed quickly, conveniently, and safely.

Refer to PACTware bulletins 59-101 and 59-601 for more information.

PACTware offers distinct advantages in loop tuning and configuration documentation.



## PROBE OVERVIEW

---

### SINGLE ROD PROBES

The pulses of energy from a single rod probe develop between the center rod and the mounting nut or flange. In other words the pulse propagates down the rod as it references its ground at the top of the tank. The efficiency of the pulse “launch” is directly related to how much metallic surface exists around it at the top of the vessel.

Figure 1 shows the single element design and how the pulse expands into a teardrop shape as it propagates away from the top of the tank (ground reference). Because the design is “open”, it is the most forgiving of coating and buildup. It is important to note that a parallel metal wall INCREASES its performance while a singular, metal object protruding near the probe may be improperly detected as a liquid level.

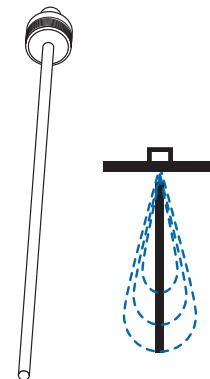

**Figure 1**  
**Single Rod Probe**

# PROBE OVERVIEW (cont.)

## NOZZLES

The 7xF Single Rod probes may be susceptible to objects that are in close proximity. The following rules should be followed for proper application:

1. Nozzle must be 3/4" (19 mm) diameter (A) or larger.
2. Ratio of diameter (A) to length (B) is 1:1 or greater. Any ratio < 1:1 (e.g., a 2" x 6" nozzle = 1:3) can be used but may require a BLOCKING DISTANCE and/or SENSITIVITY adjustment. See Figure 2.
3. Pipe reducers that create restriction should not be used. See Figure 3.

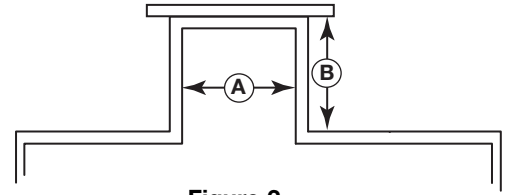

Figure 2

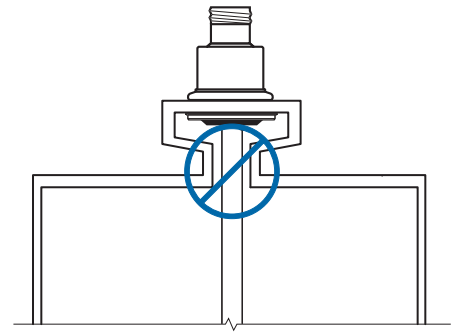

Figure 3

## OBSTRUCTIONS (METALLIC)

1. If PACTware is used for loop tuning, objects (e.g., shoulders or agitator blades) can be within 1/4" of probe.

## TURBULENCE

The bottom of a single rod probe should be stabilized if turbulence will cause a deflection of more than 3 inches (80 mm) at 10 feet (3 m) of length. A metallic capture ring can be employed at the bottom of the probe to eliminate torque build-up.

### Obstructions (Metallic) – Guidelines

Distance to probe	Acceptable objects
< 0.5" (13 mm)	Continuous, smooth, parallel, conductive surface (e.g., tank wall); probe should not touch tank wall

Figure 4

## TEMPERATURE / PRESSURE CHART

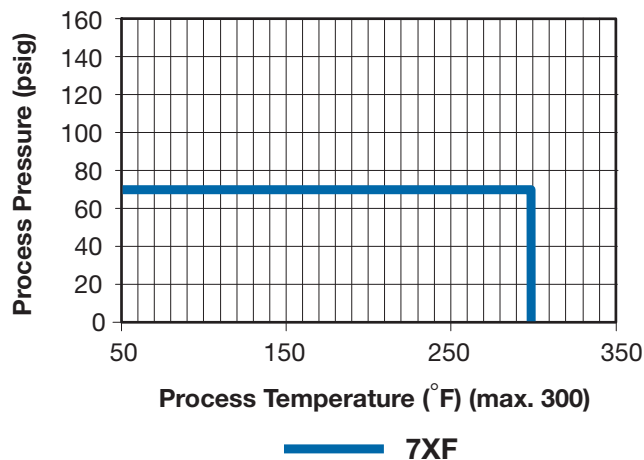

## ***Stainless Steel Housing with probe***

---



Eclipse Model 705 transmitter in a 304 SS housing for use in a variety of sanitary applications. 0.5 inch diameter 316 SS probe with a 15Ra EP surface finish is available with 3/4" thru 4" Triclover process connections.



## ***1 1/2" Sanitary Connection with bend***

---

316 SS probes can be bent to avoid internal obstructions such as agitator blades and spray balls, and to insure lowest possible level detection.



## ***3/4" Sanitary Connection without bend***

---

0.25 inch diameter probes suitable for use in smaller vessels where space is at a premium. Available in lengths up to 72 inches.



## ***Stainless Steel Housing***

---

Compact, single compartment, 304 SS housing designed specifically for sanitary industries.



# SINGLE ROD PROBE MATRIX

7xF-E, -F, -G Sanitary 	
Recommended for	Applications demanding sanitary specifications
Not recommended for	Low dielectric media ( $\epsilon_r < 1.9$ ) <sup>②</sup> ;
Materials/Wetted parts	316L SS, TFE, <15 R <sub>a</sub> finish
Optional	Hastelloy C, Monel®, AL6XN SS
Process Seal	316L SS, TFE
Diameter	∅ .50 (13 mm) rod for process connections > 1½" (24-240 inches) ∅ .25 (7 mm) for process connections < 1½" (24-72 inches)
Flange ANSI (DIN)	3/4 to 4" (38 to 100 cm); Tri-Clamp® fitting
Length	24 to 240" (60 to 610 cm)
Transition zone	1" (25 mm) @ $\epsilon_r > 10$
Top	
Bottom	1" (25 mm) @ $\epsilon_r > 10$
Blocking Distance	0-36" (0 to 91 cm) probe length/application dependent
Process temperature <sup>①</sup>	
(Maximum)	+300° F @ 75 psig (+150° C @ 5.1 bar)
Minimum (cryogenic)	Consult factory
Process pressure Max.	75 psig @ +300° F (5.1 bar @ +150° C)
Min. (vacuum service)	N/A
Dielectric range <sup>②</sup>	1.9 to 100
Maximum viscosity (cP)	10,000 (consult factory if severe agitation/turbulence)
Mounting effects	See Nozzle and obstruction notes
Coating/Buildup	Yes; maximum error 10% of coated length; % error related to dielectric of media, thickness of coating & coated probe length above media
Foam	Yes
Corrosives	Yes
Sanitary	Yes
Overfill	No
Approvals	
FM	Yes
CSA	Yes
ATEX	Yes
OTHER	No

① Refer to Ambient Temperature vs. Process Temperature graph.

②  $\epsilon_r$  1.9–10 must be mounted between 2–6" (50–150 mm) of metal tank wall.

# CURRENT SANITARY APPLICATIONS

The Model 705 transmitters are presently installed in a variety of media systems including bioreactors, fermenters, media storage, crystallizers, decanters and ultra filtration skid receivers.

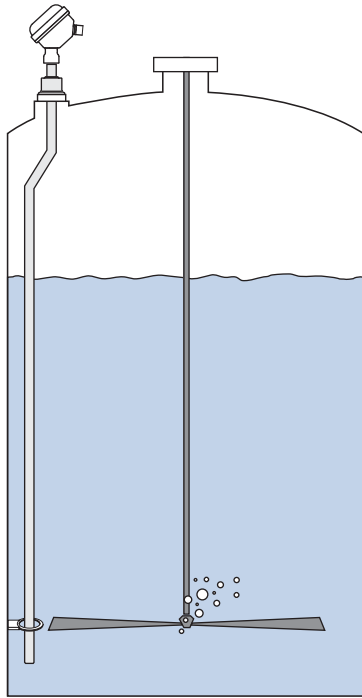

**25K Bio Reactor**

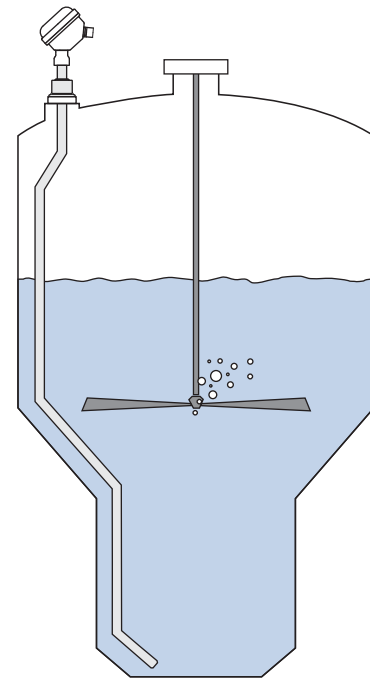

**Tulip Tank**

***Buffers systems including:***

- primary mix tanks
- hold tanks
- day tanks
- bulk tanks

***CIP systems including:***

- day tanks
- bulk tanks
- skid delivery tanks

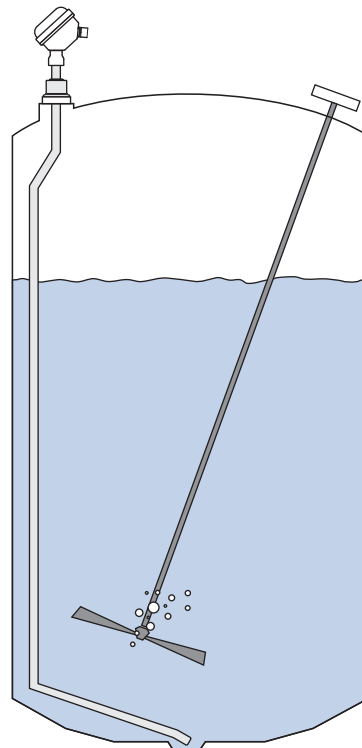

**1500K Fermentor**

***Utility systems including:***

- ammonia storage
- CO2 storage
- inlet water
- deaerator systems
- condensate receivers
- boiler drums
- fuel oil storage
- various sumps
- waste tanks
- neutralization tanks

# TRANSMITTER

## MODEL NUMBER

Models available for quick shipment, usually within one week after factory receipt of a purchase order, through the Expedite Ship Plan (ESP).

### BASIC MODEL NUMBER

705	Eclipse Guided Wave Radar Level Transmitter
-----	---

### POWER

5	24 VDC, Two-wire
---	------------------

### SIGNAL OUTPUT

1	4–20 mA with HART
2	FOUNDATION fieldbus™ Digital Communication (English only)

### OPTIONS

0	None – SIL 1 Approved
A	SIL 2 Approved

### ACCESSORIES

A	Digital display and keypad
---	----------------------------

### MOUNTING/CLASSIFICATION

1	Integral, General Purpose & Intrinsically Safe (FM & CSA), Non-incendive (Class I, Div. 2)
2	Remote, General Purpose & Intrinsically Safe (FM & CSA), Non-incendive (Class I, Div. 2)
3	Integral, Explosion Proof (FM & CSA) & Non-incendive
4	Remote, Explosion Proof (FM & CSA) & Non-incendive
A	Integral, General Purpose & Intrinsically Safe (ATEX & JIS EEx ia IIC T4)
B	Remote, General Purpose & Intrinsically Safe (ATEX & JIS EEx ia IIC T4)
C	Integral, Explosion Proof (ATEX EEx d [ia] IIC T6) (must be ordered with Conduit Connection Codes 0 and 1)
D	Remote, Explosion Proof (ATEX EEx d [ia] IIB T6) (must be ordered with Conduit Connection Codes 0 and 1)
E	Integral, Non-incendive (ATEX EEx n II T4..6)
F	Remote, Non-incendive (ATEX EEx n II T4..6)

### HOUSING

1	Cast aluminum, dual compartment, 45° angle
2	316 stainless steel, dual compartment, 45° angle
3	304 stainless steel, single compartment*

### CONDUIT CONNECTION

0	¾" NPT
1	M20
4	½" NPT*

\* Not available with explosion proof mounting/classification codes 3, 4, C, D.



# PROBE

## MODEL NUMBER

### BASIC MODEL NUMBER

7E	Eclipse GWR probe, English unit of measure
7M	Eclipse GWR probe, Metric unit of measure

### CONFIGURATION/STYLE

F	Single Rod
---	------------

### MATERIAL OF CONSTRUCTION

E	Sanitary, 316/316L stainless steel (15 R <sub>a</sub> EP finish), Process connections codes 2P, 3P, 4P, 5P, and 6P only
G	Sanitary, AL6XN stainless steel (15 R <sub>a</sub> EP finish), Process connections codes 2P, 3P, 4P, 5P, and 6P only
H	Sanitary, Hastelloy C22, 15 R <sub>a</sub> EP finish, Process connections codes 2P, 3P, 4P, 5P, and 6P only

### PROCESS CONNECTION SIZE/TYPE SANITARY FLANGE CONNECTIONS

2P	3/4" Tri Clover® type, 16 AMP Sanitary Flange
3P	1" or 1½" Triclover® type, 16 AMP Sanitary Flange
4P	2" Tri Clover® type, 16 AMP Sanitary Flange
5P	3" Tri Clover® type, 16 AMP Sanitary Flange
6P	4" Tri Clover® type, 16 AMP Sanitary Flange

### O-RINGS

N	None
---	------

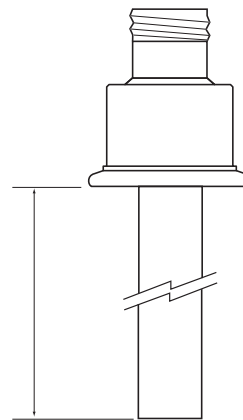

**Insertion Length  
Sanitary Flange**

### LENGTH

24 to 240 inches (60 to 610 cm)  
(unit of measure is determined by second digit of Model Number)  
Examples: 24 inches = 024; 60 centimeters = 060



# QUALITY

---



The quality assurance system in place at Magnetrol guarantees the highest level of quality throughout the company. Magnetrol is committed to providing full customer satisfaction both in quality products and quality service.

Magnetrol's quality assurance system is registered to ISO 9001 affirming its commitment to known international quality standards providing the strongest assurance of product/service quality available.

# ESP

---

## **E**xpedite **S**hip **P**lan

Several Models of Eclipse Guided Wave Radar Transmitters are available for quick shipment, usually within one week after factory receipt of a purchase order, through the Expedite Ship Plan (ESP).

Models covered by ESP service are color coded in the selection data charts.

To take advantage of ESP, simply match the color coded model number codes (standard dimensions apply).

ESP service may not apply to orders of ten units or more. Contact your local representative for lead times on larger volume orders, as well as other products and options.

# WARRANTY

---



All Magnetrol electronic level and flow controls are warranted free of defects in materials or workmanship for one full year from the date of original factory shipment.

If returned within the warranty period; and, upon factory inspection of the control, the cause of the claim is determined to be covered under the warranty; then, Magnetrol will repair or replace the control at no cost

to the purchaser (or owner) other than transportation.

Magnetrol shall not be liable for misapplication, labor claims, direct or consequential damage or expense arising from the installation or use of equipment. There are no other warranties expressed or implied, except special written warranties covering some Magnetrol products.

For additional information, see Instruction Manual 57-600.

Eclipse Guided Wave Radar transmitters may be protected by one or more of the following U.S. Patent Nos. US 6,062,095; US 6,247,362; US 6,588,272; US 6,626,038; US 6,640,629; US 6,642,807; US 6,690,320; US 6,750,808; US 6,801,157. May depend on model.

---



5300 Belmont Road • Downers Grove, Illinois 60515-4499 • 630-969-4000 • Fax 630-969-9489 • www.magnetrol.com  
145 Jardin Drive, Units 1 & 2 • Concord, Ontario Canada L4K 1X7 • 905-738-9600 • Fax 905-738-1306  
Heikensstraat 6 • B 9240 Zele, Belgium • 052 45.11.11 • Fax 052 45.09.93  
Regent Business Ctr., Jubilee Rd. • Burgess Hill, Sussex RH15 9TL U.K. • 01444-871313 • Fax 01444-871317

Copyright © 2007 Magnetrol International, Incorporated. All rights reserved. Printed in the USA.  
Performance specifications are effective with date of issue and are subject to change without notice.

Magnetrol, Magnetrol logotype, and Eclipse are registered trademarks of Magnetrol International  
HART® is a registered trademark of the HART Communication Foundation.  
Hastelloy® is a registered trademark of Haynes International.  
Monel® is a registered trademark of the INCO family of companies.  
PEEK™ is a trademark of Vitrex plc.  
Teflon® is a registered trademark of DuPont.  
Tri-Clover® is a registered trademark of Tri-Clover, Inc.  
Viton® and Kalrez® are registered trademarks of DuPont Performance Elastomers.  
©2007 Fieldbus Foundation

**BULLETIN: 57-110.2**  
**EFFECTIVE: December 2007**  
**SUPERSEDES: July 2007**